

Article number: 203250M16100A1U

Description: E+G levelling foot
GN 32-50-M16-100-A1-U

Note: U Without nut, Hexagon socket at the top, Wrench flat at the bottom

Measures

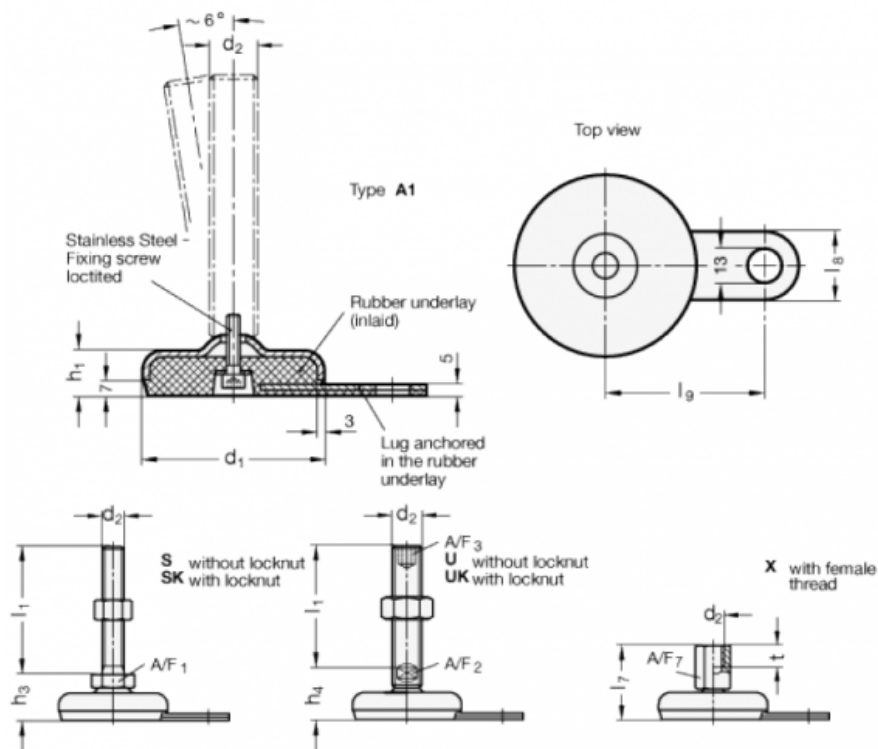

$$A/F2 = 12$$

$$l9 = 45$$

$$A/F3 = 8$$

$$d1 = 50$$

$$d2 = M16$$

$$h1 = 18$$

$$h4 = 32$$

$$l1 = 100$$

$$l8 = 25$$